

# DROP INLET

24"x24" I.D.  
(NOMINAL DIMENSIONS)  
WITH FRAME AND GRATE

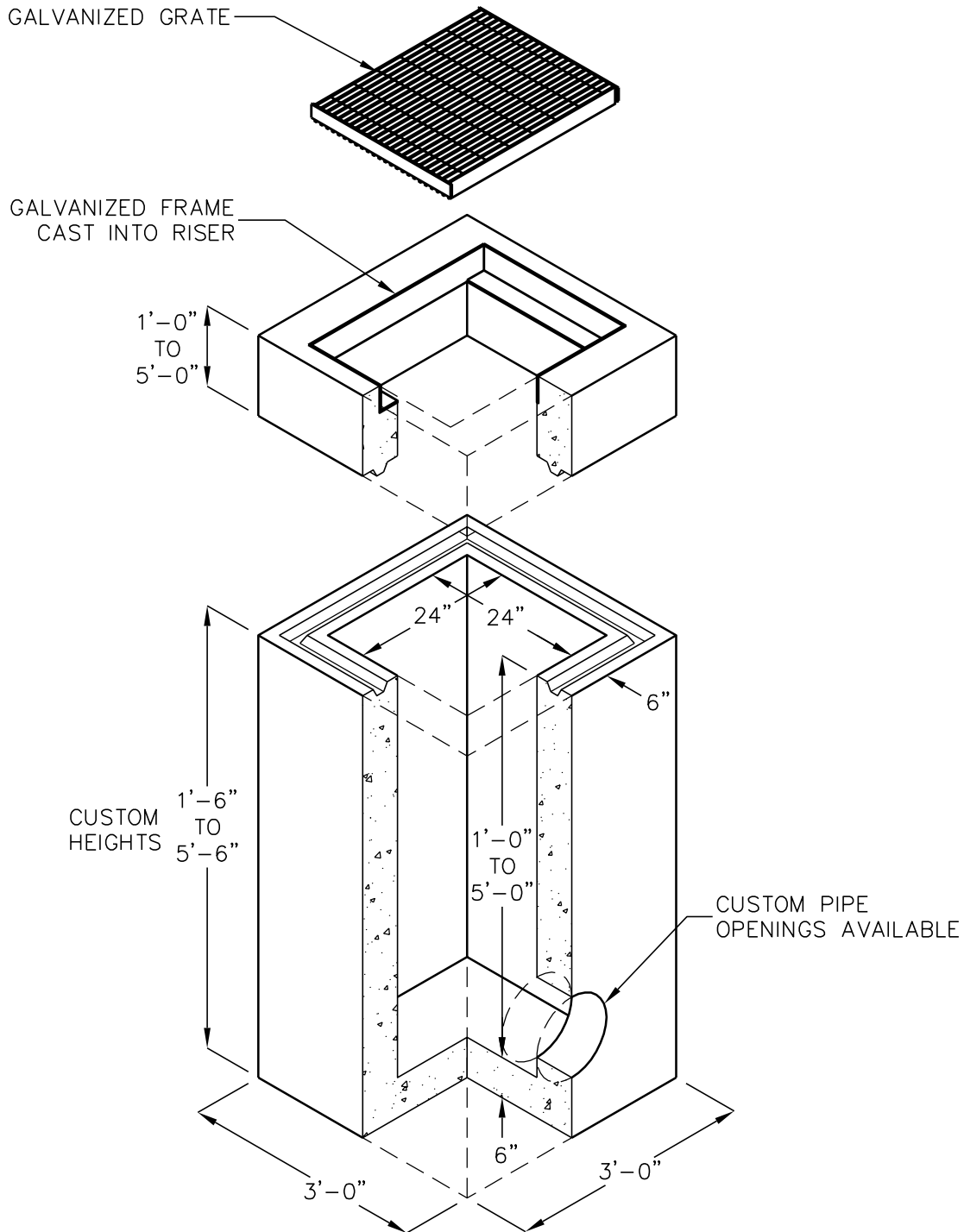

FOR COMPLETE DESIGN AND PRODUCT INFORMATION  
CONTACT JENSEN PRECAST.